

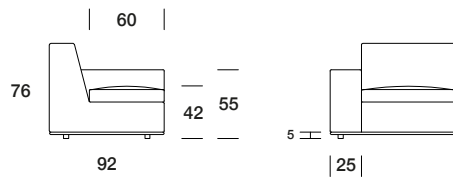

Divano

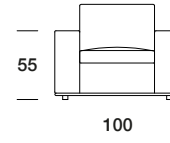

Poltrona



Love seat

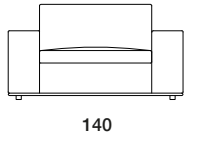

STEVE EVO

Divano

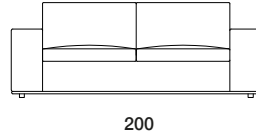

Divano

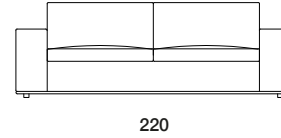

Divano

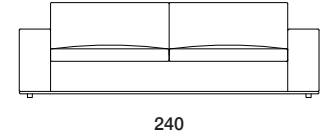

Poltrona terminale SX

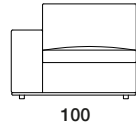

Poltrona terminale DX

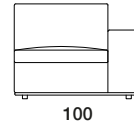

Divano terminale SX

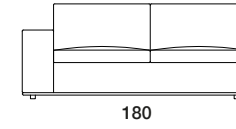

Divano terminale DX

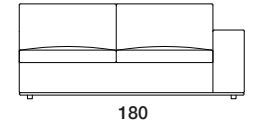

Divano terminale SX

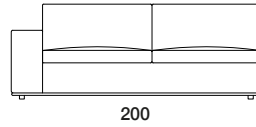

Divano terminale DX

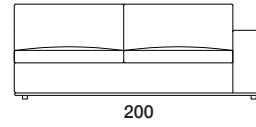

Poltrona centrale

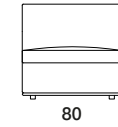

Divano centrale

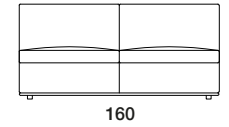

Angolo / Poltrona terminale

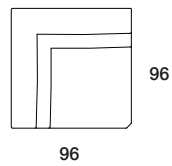

Angolo large

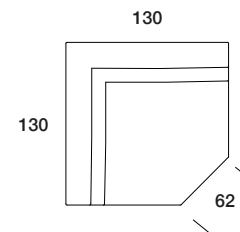

Poggiatesta

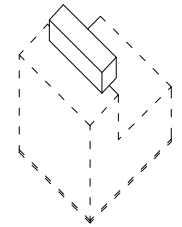

Elemento D Small SX

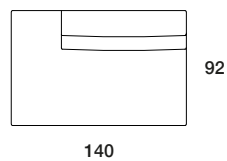

Elemento D Small DX

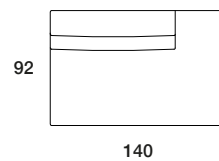

Chaise longue SX

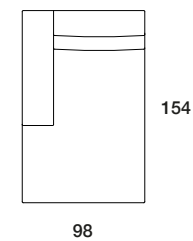

Chaise longue DX

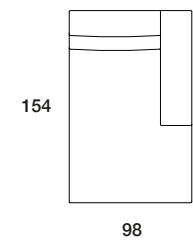

Pouff

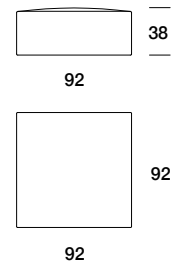
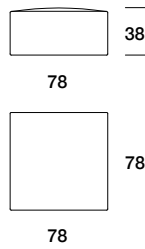

Elemento K SX

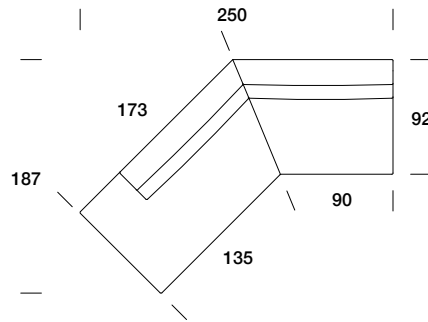

Elemento K SX

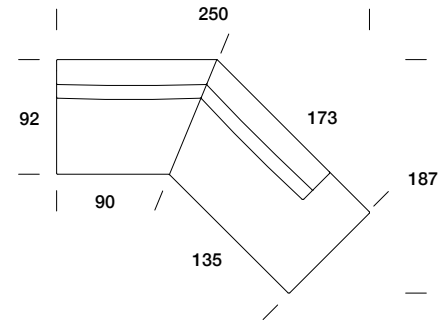

Elemento Y SX

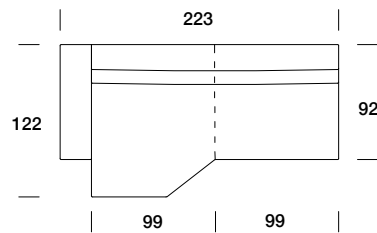

Elemento Y DX

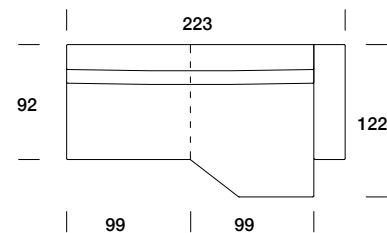

Composizione1

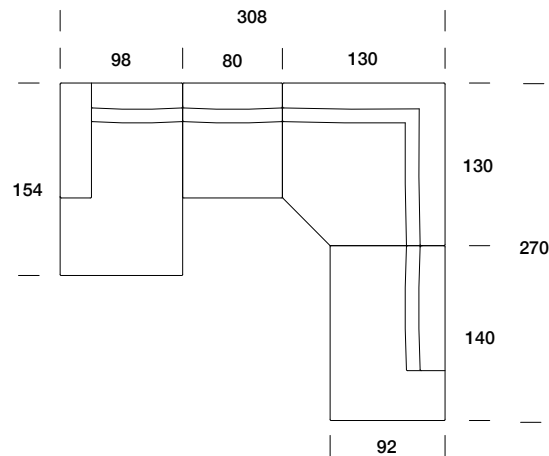

Composizione2

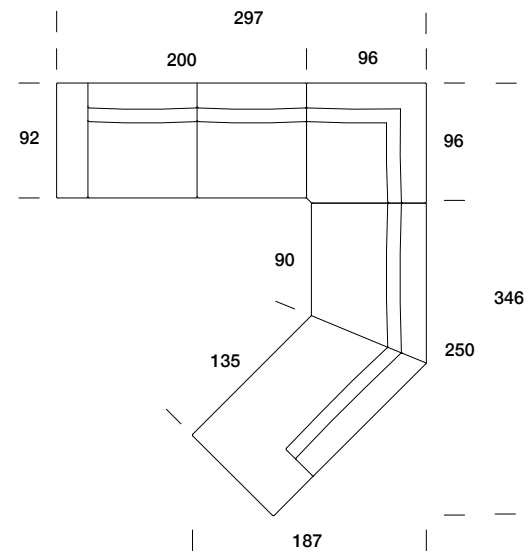

Elementi imbottiti completamente sfoderabili nella versione in tessuto. Struttura portante in legno massello, cuscini seduta in misto piuma con inserto in poliuretano. Base in metallo.

Upholstered elements with removable covers in case of fabric upholstery. Solid wood bearing structure, seat cushions in mixed feather with high density polyurethane foam inserts. Metal base.